



14500 Coy Drive, Grass Lake, Michigan 49240
734-475-2200 E-mail: sales@coylab.com
www.coylab.com

Gloveless Anaerobic Chamber Instruction Manual *(Polymer Glove Box Style)*

1.0 DESCRIPTION

WARNING

- 1.1 INTRODUCTION
- 1.1 WARRANTY
- 1.2 GENERAL INFORMATION
- 1.3 CHAMBER ASSEMBLY & COMPONENT PLACEMENT

2.0 SYSTEM FUNCTION IN THE CHAMBER

1. Touch Screen Controls (heated units only)
 - Temperature
 - Dehumidifier
 - Purge Airlock
 - Gas Injection System
 - Glove Box Purge
 - Temperature and Dehumidifier Calibration
2. Plug Strip
3. Diaphragm Top
4. Gas Regulators (N₂ and Gas Mix)
5. Heated Circulation Fan (2 Person Units only)*
6. Gloveless Sleeves & Arm Port Plugs
7. Catalyst Stak-Pak

2.1 OPTIONAL EQUIPMENT

1. OXYGEN/HYDROGEN ANALYZER
2. INCANDESCENT FLAMING DEVICE
3. POP LOCK
4. ATMOSP
5. ATMOSPHERE FILTER

3.0 PURGING THE CHAMBER & GETTING STARTED

4.0 THEORY OF DESIGN

- 2.1 PALLADIUM CATALYST/GAS REACTION
- 2.2 OXYGEN ENTERING THROUGH AIRLOCK
- 2.3 CONTROLLING MOISTURE

5.0 CARE AND MAINTENANCE

- 3.1 CARE OF POLYCARBONATE
- 3.2 CARE OF GLOVES

6.0 *FREQUENTLY ASKED QUESTIONS AND ANSWERS*

1.0 INTRODUCTION

WARNING

DO NOT USE **PURE** HYDROGEN IN ESTABLISHING YOUR CHAMBER ENVIRONMENT.

USE ONLY PRE-MIXED GASES.

THE USE OF PURE HYDROGEN, OR PRE-MIXED GASES WITH A HYDROGEN CONTENT OF GREATER THAN 4%, MAY CAUSE AN EXPLOSIVE MIXTURE TO EXIST IN YOUR CHAMBER.

LATEX WARNING

LATEX GLOVES WITH POWDER MAY BE INSTALLED ON THIS EQUIPMENT. SOME PEOPLE ARE ALLERGIC TO LATEX AND/OR THE POWDER. COY LABORATORY PRODUCTS CANNOT ACCOUNT FOR THE CONTENT OF GLOVES BOUGHT FROM OTHER VENDORS.

1.1 WARRANTY

THE ELECTRONIC COMPONENTS CONTAINED IN THIS CHAMBER ARE WARRANTED AGAINST DEFECTS IN MATERIAL AND WORKMANSHIP DURING THE FIRST 12 MONTHS AFTER ORIGINAL DATE OF SHIPMENT.

THE FACTORY WILL, AT ITS OPTION, REPAIR OR REPLACE DEFECTIVE MATERIALS WITHIN THE ABOVE PERIODS AT NO CHARGE FOR PARTS AND LABOR.

ALL RETURNS OR EXCHANGES MUST FIRST BE AUTHORIZED BY COY LABORATORY PRODUCTS, INC.

PHONE: 734-475-2200

FAX: 734-475-1846

COY LABORATORY PRODUCTS, INC.

14500 COY DRIVE, GRASS LAKE, MICHIGAN 49240

THE RESPONSIBILITY OF COY LABORATORY PRODUCTS, INC., IS LIMITED TO THE PURCHASE PRICE OF THIS PRODUCT, AND COY LABORATORY PRODUCTS, INC. WILL NOT BE RESPONSIBLE FOR ANY CONSEQUENTIAL DAMAGES.

THIS WARRANTY DOES NOT COVER DAMAGE IN SHIPMENT OR DAMAGE AS A RESULT OF IMPROPER USE OR MAINTENANCE OF THIS PRODUCT. THIS WARRANTY DOES NOT COVER DAMAGES CAUSED BY EXCESSIVE LINE TRANSIENTS ON THE AC SUPPLY LINE.

1.2 GENERAL INFORMATION

- 1.2.1 This manual is designed to provide you with basic knowledge of a Coy Polymer Glove Box (PGB) and the components supporting it for gloveless anaerobic use. The manual provides insight on how to assemble, operate, and maintain the Chamber. We strongly recommend that all laboratory personnel and Chamber users read the manual to become familiar with assembly, operation, care, maintenance and theory of anaerobic conditions.
- 1.2.2 The Coy PGB is available in three, four, or five foot lengths and is constructed of Polycarbonate. The 3 ft. model has two arm ports, while the 4 ft. model has three, 2 are designed to be the gloveless workstation while the 3rd glove port, closest to the airlock is equipped with a sleeve length glove to quickly transfer samples in and out of the glove box. The 5 ft. length has 4 arm ports or 2 pair. The Glove Box has a removable rear panel (32" L x 19" H) and a Large Side Door on one end to allow the introduction of equipment, and an Airlock on the other end for your product to be moved in or out. A circulation fan is supplied with the Chamber to ensure a uniform anaerobic environment. The fan circulates the Chamber's atmosphere through palladium catalyst to remove oxygen. It should be noted here that **HYDROGEN** must be present in order for the palladium catalyst to properly remove oxygen. The Palladium Catalyst is contained within a COY Stak-Pak that sits conveniently on top of the Catalyst Holder. Temperature and Humidity controls are standard on all units.

Figure #1A: Standard Glove Box Floor Plan (4 ft. Version)

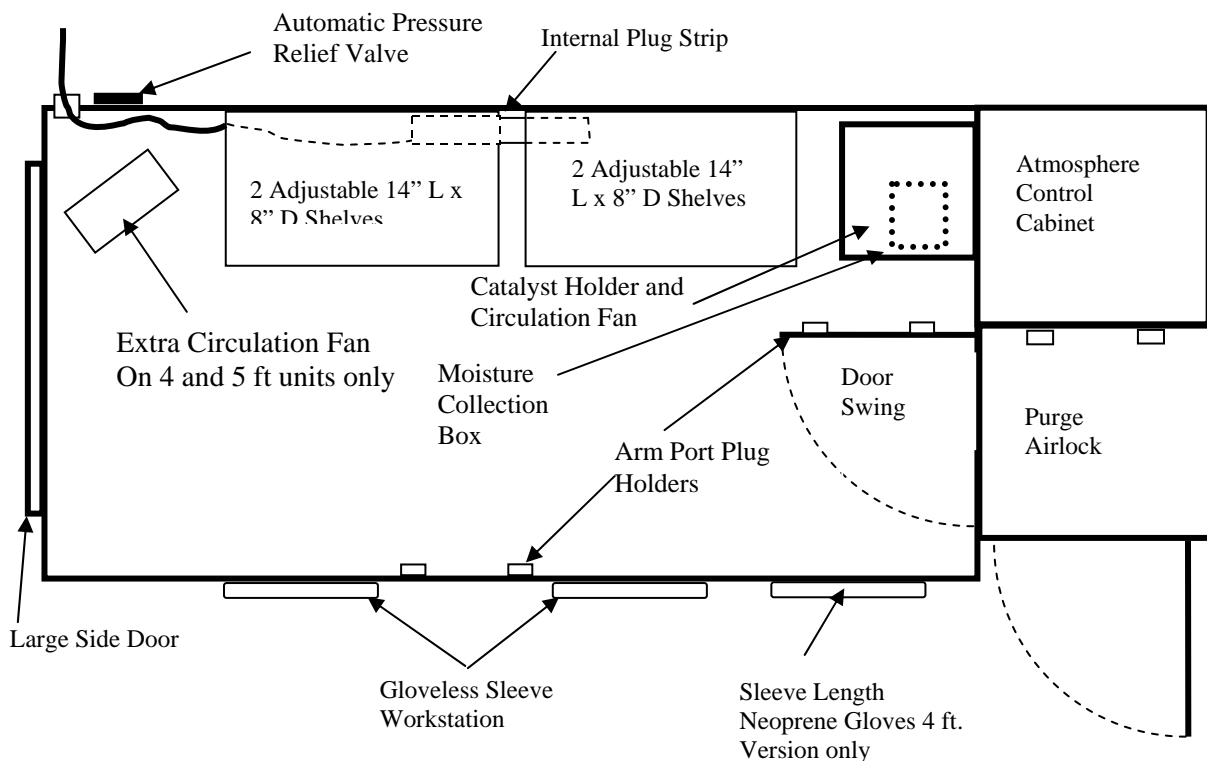
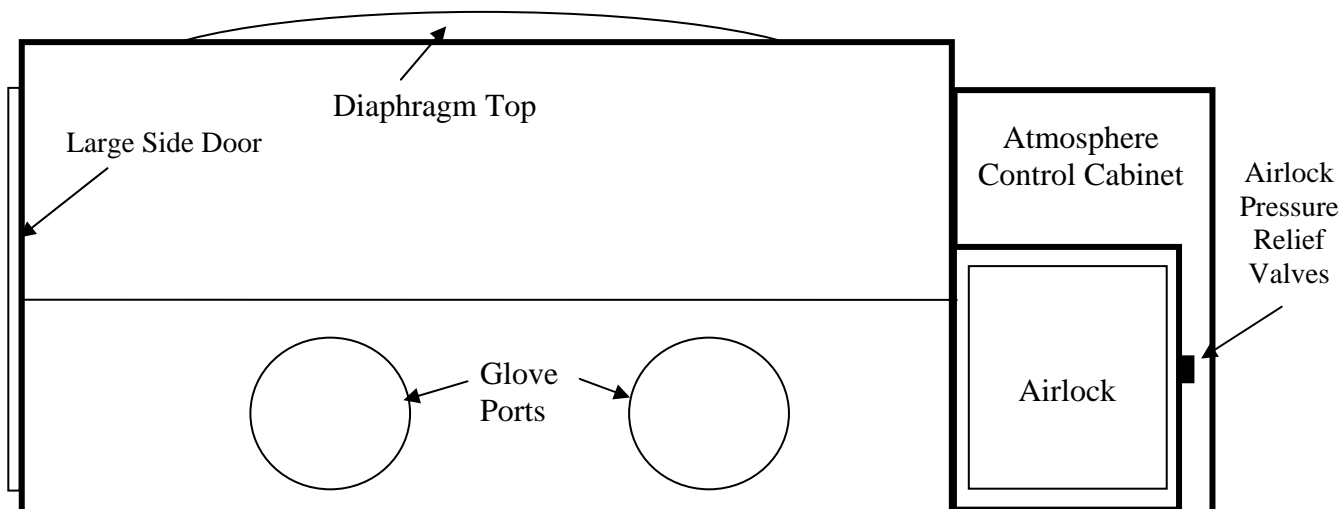

Figure #1B: Standard Glove Box Front View (3 ft. version)



List of Standard Accessory Items Included

- Gas Mix regulator with tubing (for H₂ Gas Mixes only)
- Nitrogen Gas Regulator with Tubing
- 2 Catalyst Stak-Pak
- 4 Shelves with 8 Support Brackets
- Arm Port Plugs (number varies based on size of the unit purchased)
- Gloveless Sleeves (1 or 2 pairs)
- Sleeve Length Glove
- (4 ft. size Unit only)
- Bottle for collecting excess moisture
- 6 pair of Replacement Cuffs for the gloveless sleeves
- Secondary Circulation Fan 4 & 5 ft. Units only (heated version in 5 ft unit)

1.3 CHAMBER ASSEMBLY

1.3.1 Before shipment all parts have been assembled and tested for leaks.

For Set Up:

1. Remove all packing material. Place the Arm Port Plugs into the arm port holders attached to the front and side of the glove box (see Figure #2 for details). The Gloveless Sleeves are installed at the factory.

Figure #2: Arm Port Plug Placement

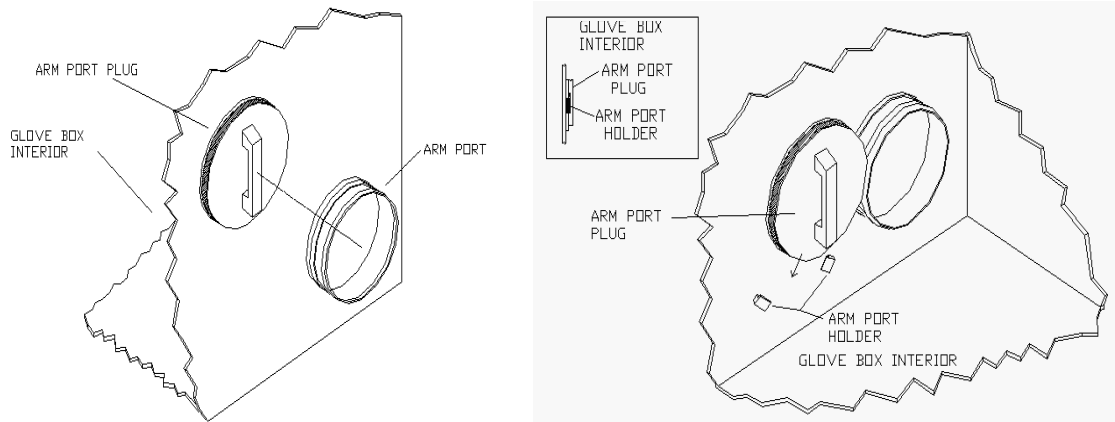

2. Attach the Gas Mix Regulator to your H₂ Gas Mix Tank. Measure and cut a length of tubing from this regulator to the quick disconnect fitting of the Atmosphere Control Cabinet labeled Gas Mix Inlet

See figure #3A and #3B for details on connecting tubing and using the quick disconnect fittings.

3. Attach the Nitrogen regulator to your background (N₂) gas tank. Measure and cut a length of tubing from the nitrogen regulator to the back of the Atmosphere Control Cabinet Quick Disconnect fitting labeled Background Gas Inlet.

Both gas regulators should be adjusted to 15 psi (pounds per square inch) output or lower. Higher flow rates can damage the glove box. If the tanks or Gas source are placed over 10 ft away you may adjust the flow rate +5 psi for every 10 ft. distance traveled beyond 10 ft.

Figure #3A: Tubing connection to Quick Disconnect Fitting

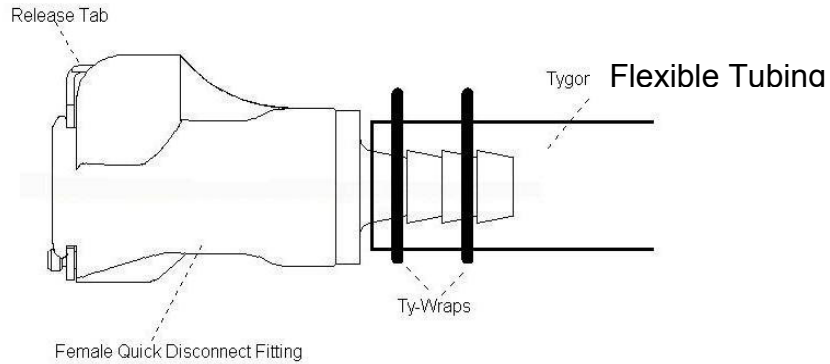
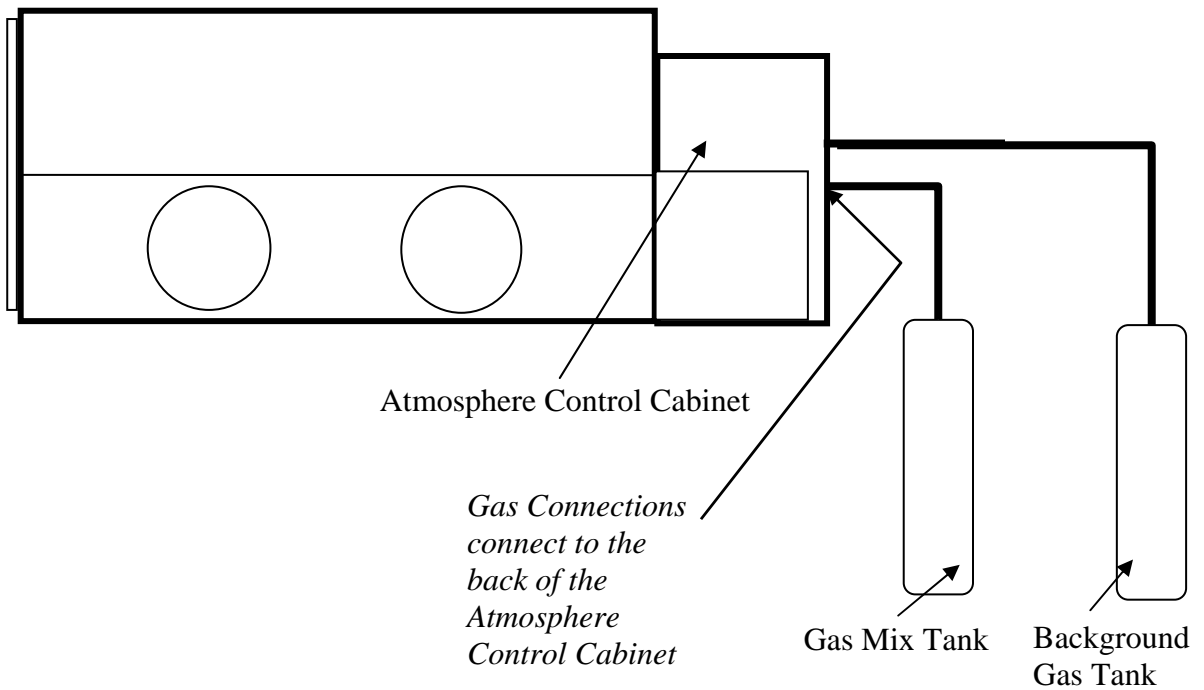

Figure #3B: Glove Box Gas Connections



4. Place the foot-switch for the gloveless sleeve vacuum/purge system in a comfortable position in front of the operator's position.
5. Large equipment will be placed inside the chamber through the Large Side Door.

4 and 5 ft. Size Units Only

6. Install the 2nd circulation fan, the unit is shipped with the brackets already installed but you will have to install the fan unit yourself. To install the fan, remove the black knobs (bolts) from the side of the fan/heater unit and install the fan to the fan base mounted into the chamber. (see Figure #4). When installing the fan unit the Power Cord should always face the rear of the glove box. Adjust angle of the fan so that the airflow is pointed toward the top third of the glove box and tighten the bolts holding it in place. Plug power cord into the Supplied Plug Strip. On the back of the circulation fan for the One Person units is a OFF/HI/LOW switch, for best temperature and humidity uniformity in the glove box this should remain in the HI position.

For the Heated Fans on the 2 Person Units the fan starts automatically when the plug strip is turned on. For operation of the temperature controls please see section 1.5 page 19 & 20.

Figure #4: Circulation & Heater Fan Assembly

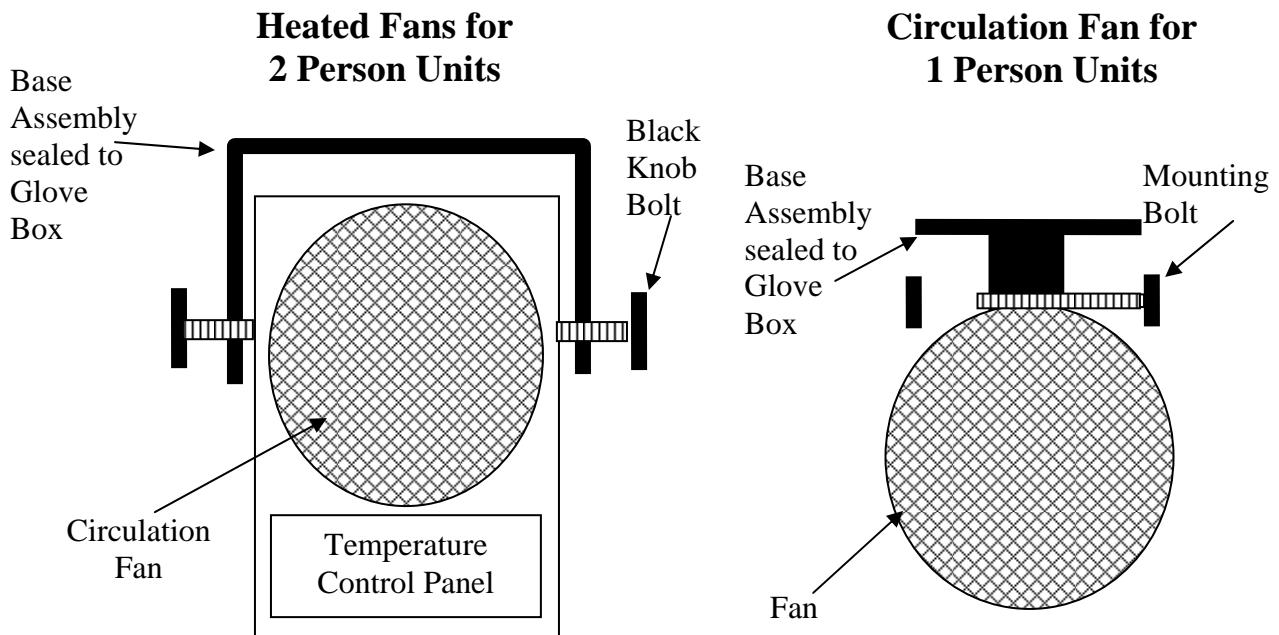

8. Finally, install the Shelves by placing the brackets into the rails on the rear of the glove box. NOTE: to ensure a secure fit it is best to use a rubber mallet to firmly tap these brackets into the rails.

2.0 SYSTEM FUNCTION IN CHAMBER

2.1 Standard Equipment

*Note: Some of the following items (noted with a *) come with a complete manual which should be consulted for more detailed information prior to operation.*

1. Touch Screen Controls (heated units only)
 - Temperature
 - Dehumidifier
 - Purge Airlock
 - Gas Injection System
 - Glove Box Purge
 - Temperature and Dehumidifier Calibration
2. Plug Strip
3. Diaphragm Top
4. Gas Regulators (N₂ and Gas Mix)
5. Heated Circulation Fan (2 Person Units only)*
6. Gloveless Sleeves & Arm Port Plugs
7. Catalyst Stak-Pak

2.1.1 Atmosphere Control Cabinet Touch Screen Controls

Figure #5: Atmosphere Control Cabinet Control Panel

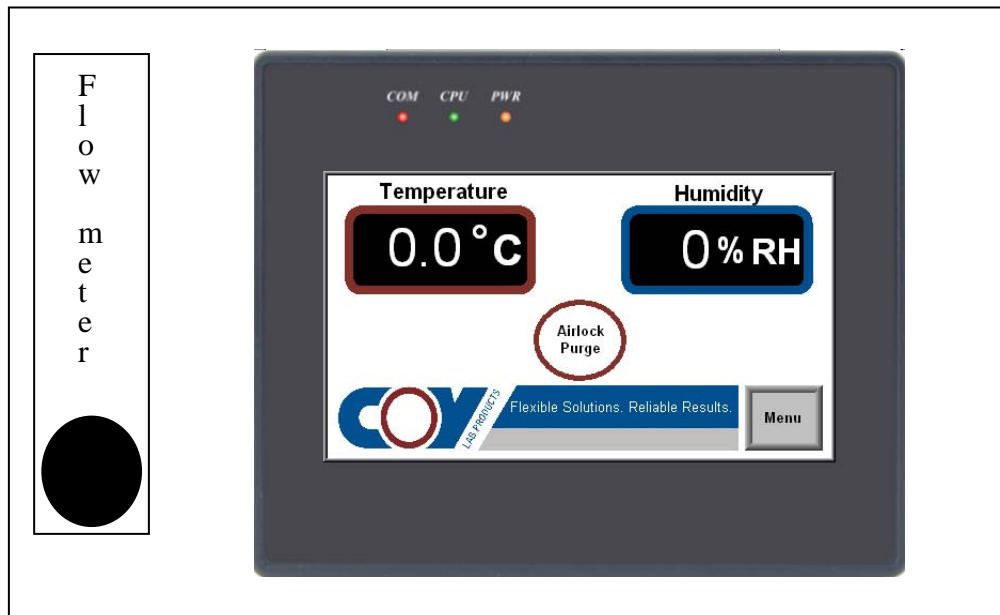

General Touch Screen Menu Guide

The touch screen controls allow you to control airlock purge times, direct glove box purge, Temperature set points and On/Off controls for the dehumidifier.

Touching the logo will send you to a Help menu for Frequently Asked Questions, System Menu which controls the screen saver and calibration menu and related COY Products Menu you may find useful in the future.



The  icon will return you to the home screen (see above).



The  icon will send you back to the previous page.

A Screen Saver is present that will send the monitor to a black screen (looks like the unit is off except for the top LED's lit. Touching any part of the screen will remove the screen saver.

LED's Lit with Screen Saver



The Screen Saver timer is adjustable and accessible through the **Menu > Help > System buttons**. Timer adjustment is in minutes with 255 minutes the maximum allowable.

Also in the help menu is a frequently asked questions (FAQ) guide.

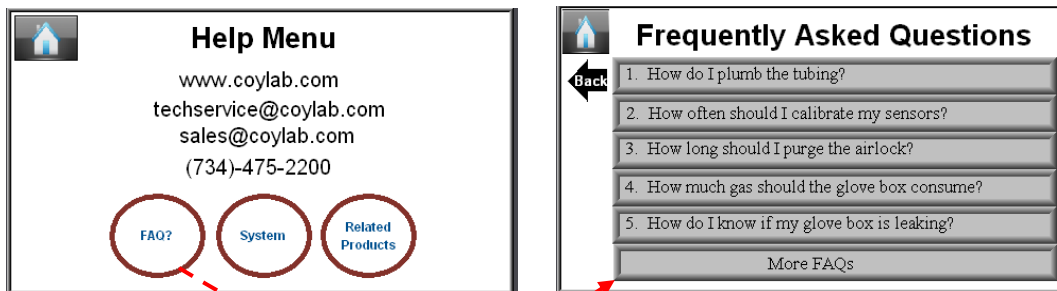

2.1.2 Temperature Control: how to input the desired set point.

Temperature can be controlled from +4 ambient to 40° C using the touch screen menu. To adjust the temperature follow use the following instructions.

This control is based on the thermal couple that's location can be adjusted inside the glove box. The Ideal Placement will be on 1 of the shelf units placed so that the air flow is not blocked and the thermal couple is not in contact with anything.

- 1. Press Menu Button

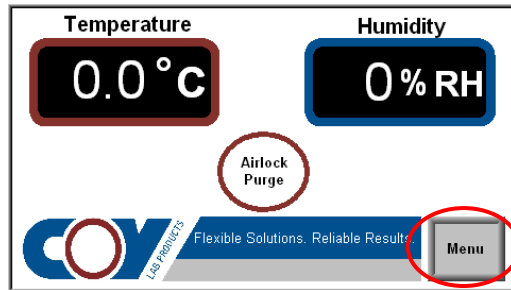

- 2. Press Temperature Setpoint menu button

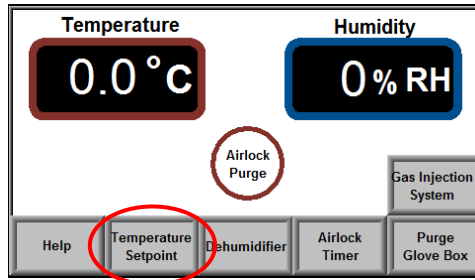

- 3. Enter the desired set point 1 of 2 ways. By clicking the green arrow buttons (up/down) on either side of the set point. until desired temperature is reached or press the center of the red set point to bring up the quick screen button (hint: looks like a calculator).

Green Arrow Buttons

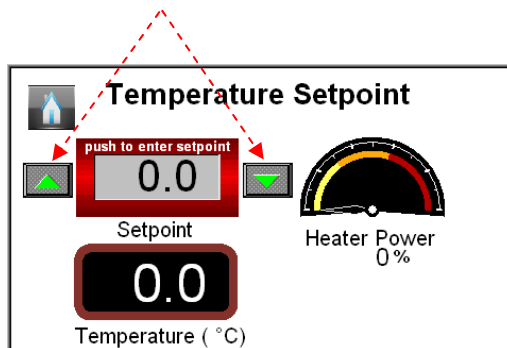

Selected the desired set point from this menu and press enter. The Heater Power display simply indicates that the internal heaters of the glove box are on and working. The chosen set point will be displayed in the bottom display.

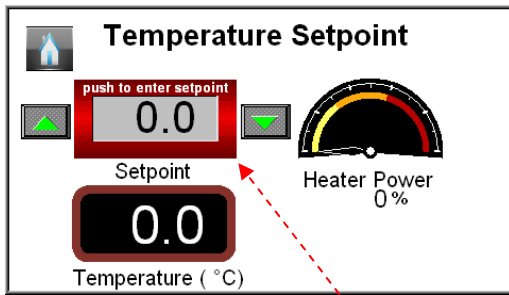

Clicking the center of the Set Point brings up the set point menu indicated here on the right

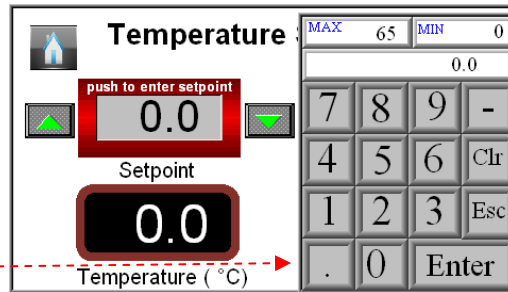

2.1.3 Dehumidifier On/Off

The built in dehumidifier is designed to maintain non-condensing levels of moisture in the chamber and for most studies should be in the On position. This should maintain between 30-35% Rh.

To Access the Dehumidifier menu and On/Off buttons press the Humidity Display (alternatively you can access this through the menu).

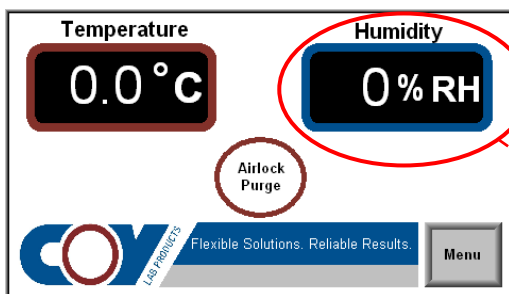

On/Off button

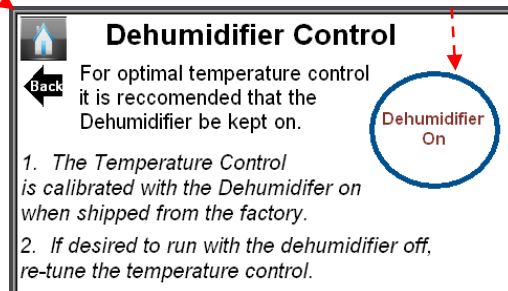

NOTE: When the Dehumidifier is turned off the primary display/monitoring page will indicate this with a icon under the %Rh display (see the example below)

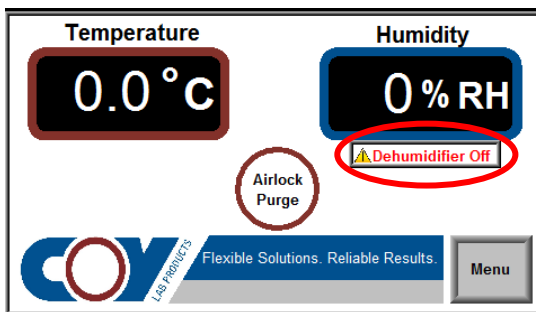

For optimal Temperature control it is recommended to operate the system with the Dehumidifier on. In addition to better temperature accuracy it will also minimize O₂ and CO₂ sensor failure due to moisture. If you do wish to operate the system with the dehumidifier in the off position it is recommended that you recalibrate the temperature controls.

2.1.4 Purge Airlock

This unit purges the small cabinet (airlock) on the side of the glove box for a set amount of time at an adjustable flow rate by the user, to reduce the amount of oxygen that is introduced to the Glove Box when bringing in or removing materials and equipment.

Flow Meter



Rates are adjusted using a Flow meter located to the left of the touch screen control panel. Flow Meter should be preset prior to starting any use of the glove box. To preset the Flow meter you must have flow through the system. Using the black knob at the bottom of the flow meter will increase or decrease this flow rate. The measurement's are in SCFH (Standard Cubic Feet per Hour) from 0-180. The times in the sample chart for O₂ levels below assume 90 SCFH. *NOTE: Read the top of the silver float*

Start/Stop the airlock purge process

The default monitoring screen displays the airlock start purge button in the center of the screen. Pressing this button will start the purge process for the amount of time selected. Once the button is pressed a timer appears counting down the purge time (you should

also hear the air flow). A “STOP” Icon is displayed allowing the user to stop any purge in process. Once the stop button is pressed the timer will reset.

Note: if the timer is set for a very short period of time you may not notice the timer count down when pressing this button.

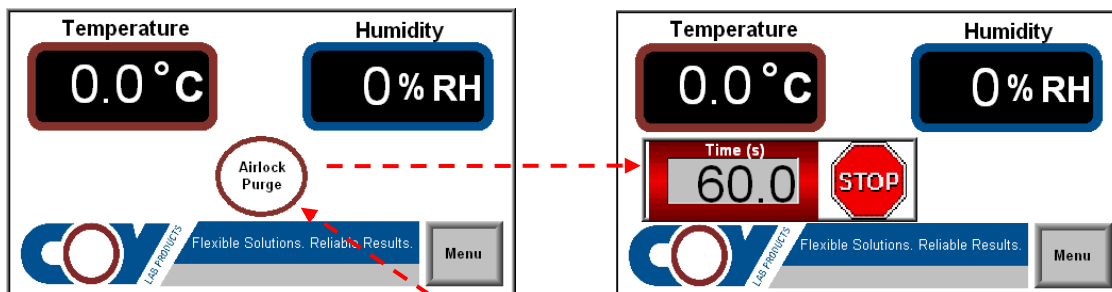

Pressing here brings up the Airlock Purge count down timer.

Adjusting Airlock Timer

NOTE: you can NOT operate the glove box purge and the airlock purge at the same time.

Purge times can be adjusted to account for various O₂ levels, and is the easiest way for most users to make adjustments for the various O₂ levels needed.

To adjust times use the following steps

1. Press Menu Button

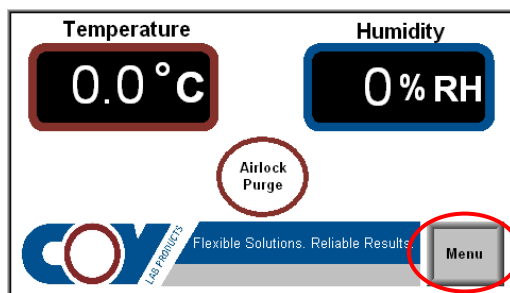

2. Press Airlock Timer button

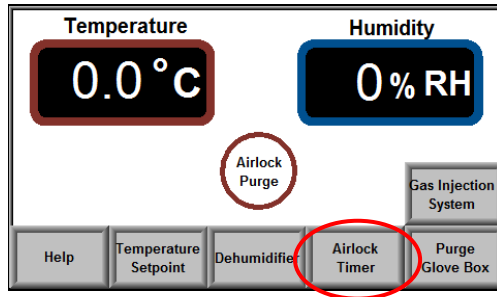

3a. Enter the desired time 1 of 3 ways. By clicking one of the 5 preset quick key times listed below the STOP button. *NOTE: The times are listed in seconds.* Once pressed the timer in the red block will change immediately. The purge can also be started or stopped from this screen.

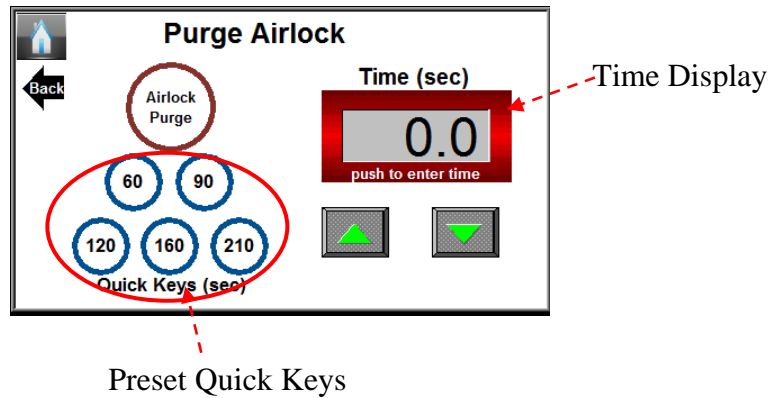

3b. The second option for adjusting time is to press the green arrows up or down. This method is typical used when slight adjustments are needed from an established time.

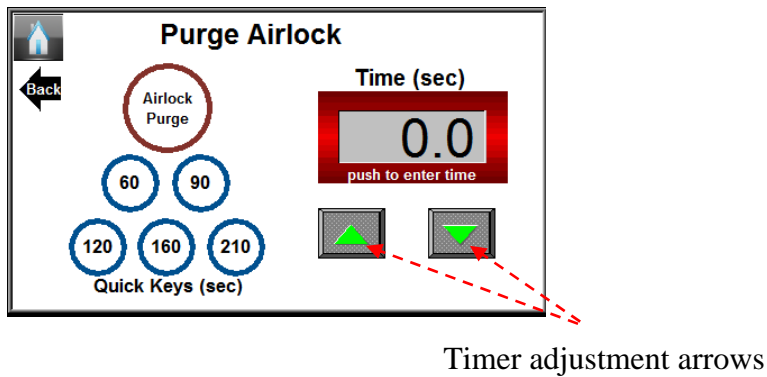

3c. The third option is to press the center of the timer display to bring up the timer number pad. Using the number pad you can enter the desired time (3 digit max) and press the enter button. Note the minus sign will allow you to enter a minus time but will not work. Esc button closes the number pad.

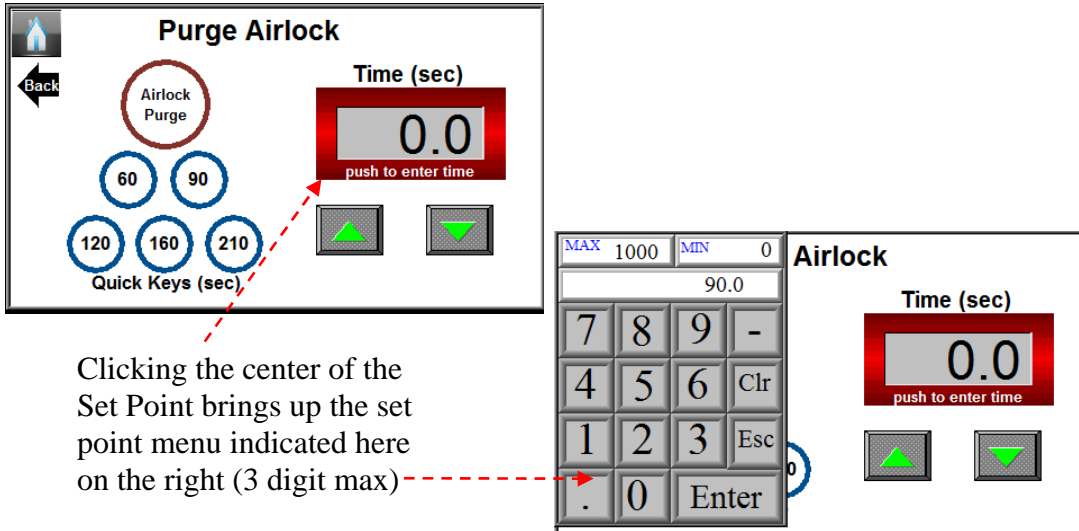

Clicking the center of the Set Point brings up the set point menu indicated here on the right (3 digit max)

Airlock Operation

1. Be sure both airlock doors are closed.
2. Set the timer for the desired purge time in seconds. Below are the sample times suggested by COY Labs however it is important to note that these times were tested with empty airlocks and as close to atmospheric O₂ as possible. Depending on your chambers recent activity these times may need to be adjusted to minimize gas consumption.

Purge Airlock Times

Gas = Nitrogen 95% Carbon Dioxide 5%

All measurements taken with a starting oxygen concentration of 20.9% (ambient)

Flow Rate (SCFH) <i>Standard Cubic Feet per Hour</i>	Time <i>(Seconds)</i>	Final O ₂ Concentration in the Airlock (%)
90	120	3.0
90	160	1.0
90	210	.05

Experiment with your system to find the optimum setting for your application.

3. Press the start button and be sure the gas flow rate is correct. Warning: you must check the flow rate as there is no warning light for lack of gas flow.

Never Purge the airlock at a rate higher than 15 psi with ¼ OD Tubing.

2.1.5 Gas Injection System

The automatic gas injection system is designed to maintain a constant level of hydrogen gas mix in your chamber, ensuring that there is always enough hydrogen present to maintain an anaerobic environment. It injects the hydrogen gas mix into your chamber for a fixed time period on a fixed time schedule. The controller (pictured below) automatically controls the time and frequency of the gas flow through user adjustable times:

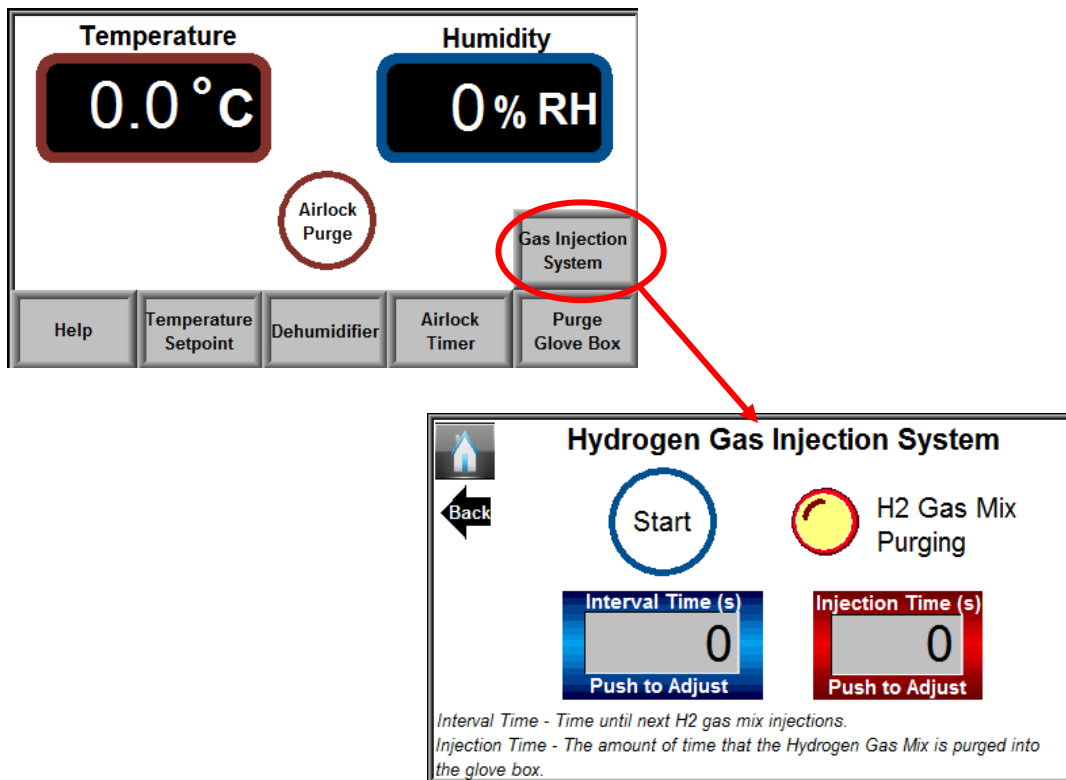

The factory settings for the injection interval are 3600 seconds (1 Hour) and the injection

time is 5 seconds. These may or may not be ideal times for your lab, chamber and application there are merely a starting point.

If you have a COY Anaerobic Gas Monitor you can observe the H₂ levels and note if they are dropping over a set period of time you will have to increase one of the timers. We don't recommend adjusting both timers, be consistent with 1 timer as a control mechanism. Conversely if you never notice the H₂ levels drop or even increasing gradually you may be using too much H₂ and thus wasting gas, and thus a lower setting should be tried with careful monitoring.

If you do not have a H₂ monitor you may use an oxygen indicator and note how long between intervals you can maintain anaerobic conditions (turn the injection time to 0 so that you are not adding any H₂ to the unit.) Manually purge the unit and time the purge for 2 to 3 minutes. You can then calculate your interval time and injection time from these observations.

If your protocols or chamber activity change dramatically you may have to adjust the settings.

2.2 Plug Strip

The six receptacle plug strip supplies proper voltage to the interior of the Glove Box. The outlets are used for continuously operating equipment, such as Fan Boxes, Incubator, and miscellaneous lab equipment you may wish to provide. The Plug Strip is sealed into the chamber through a feed through adapter with a rubber stopper. If the plug strip is adjusted for length, you may need to smear some fresh silicone around the outside portion of the feed through adapter to ensure the air tight seal.

2.3 Diaphragm Top

As the user enters the Glove Box through the Gloveless Sleeves, their hands are changing the volume inside the glove box. The Diaphragm Top expands and contracts with the changing volume, maintaining a comfortable and uniform internal pressure. The top of the Glove Box should be clear of all obstructions to allow the Diaphragm Top to fully expand (6-8"). If the Flexible vinyl material should be punctured, it is generally easy to fix with a piece of tape as a temporary fix. COY Labs does provide vinyl repair kits at no cost to repair small cuts in the vinyl.

2.4 Gas Regulators N₂ and Gas Mix

Gas Pressure Regulators decrease the pressure exiting from your gas supply

(primary pressure) to a pressure suitable for the Airlock , Gas Injection System, and the Chamber Purge (secondary pressure). The secondary pressure must **not exceed 15 psi** (4.2Kg/sq.cm), if the tanks are within approximately 10 feet (3 meter) of the airlock. If you extend the gas lines, you may need to set the regulators higher than 15 psi (1.4 Kg/sq. cm) to produce the same flow of gas.

Once the Gas Regulators are installed and all tubing is connected properly, slowly open the supply tanks. The primary pressure gauge will now display the amount of gas remaining in the tank. Turn the pressure gauge valve to regulate the gas flow to the airlock (secondary pressure gauge) to read 15 psi.

2.5 Heated Circulation Fan 2 Person Units Only

Use Figure #6 as a reference.

For temperature uniformity a second heated fan is added to the systems on the larger Two Person units. With the unit plugged into the COY supplied interior power supply the fan will begin to circulate but the temperature controls will need to be turned on and the set-point adjusted to the desired level.

The thermostat will control the temperature by turning the heat coils "on" and "off". When the coils are "on", a dot appears to the left of the temperature reading. The fan runs continuously while the power switch is "on" regardless of temperature setting. You may adjust the set point by simply pressing set point waiting for the display to change to SP and then adjusting the desired set point up or down. The "Entry" key must be pressed to accept the new set point.

Figure #6 Digital Controls for Heated Circulation Fan

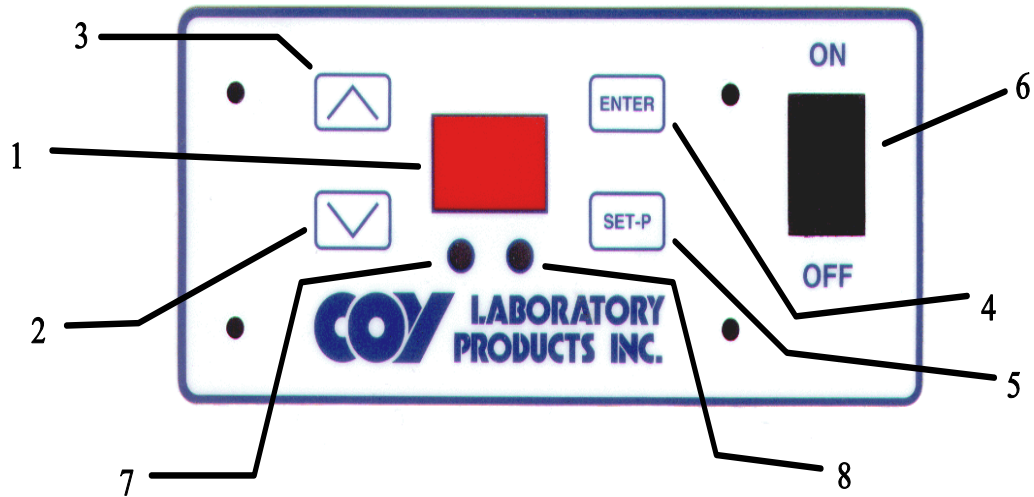

1. Display

Displays the temperature, set point or the tune values.

2. Down Arrow Key

Used to lower the set point or change the tune values.

3. Up Arrow Key

Used to increase the set point or change the tune values.

4. ENTER Key

Used to enter the value after it has been changed or to go to the next setting and also to enter the Hidden menu.

5. SET-P Key

Used to enter set point menu.

6. Main Power Switch

Used to turn power “on” and “off”.

7. Green Led

Used to indicate if the cooling output is “on” or “off”. (This can be disabled in the Hidden Menu)

8. RED Led

Used to indicate if the heaters are “on” or “off”.

PROGRAMING THE TEMPERATURE FOR SECONDARY HEATER

Use figure #6 as a reference

1. Press the SET-P Key(5) the Display(1) shows the letters “SP”, and then the Display will show the set point temperature.
2. Use the Up Arrow(3) or the Down Arrow(2) Key to change the temperature set point value.

(IMPORTANT: YOU MUST PRESS AND HOLD THE ARROW KEY WHEN CHANGING ANY VALUE. PRESSING AND RELEASING THE KEY WILL NOT CHANGE THE VALUE.)

3. After you reach the set point value desired press the ENTER KEY(4). Note: After the set point is reached there is a 20 second delay in the menu. If you have not pressed ENTER in that time frame the controller will exit this menu. The ENTER KEY(4) has to be pressed for the controller to accept the new set point value.

NOTE: When the heaters are on the Red LED (8) is turned on

2.6 Gloveless Sleeves & Arm Port Plugs

The Gloveless Sleeves and Arm Port Plugs are designed to allow barehanded access to the glove box while allowing a minimal amount of O₂ into the system. When used properly following the instructions the little amount that is introduced is quickly removed from the system through the catalyst. Place the Foot Switch under the chamber and work bench/table the unit is supported by. The plumbing and set up for this vacuum sleeve operation is set up at the factory the only set up need is to place the foot switch within easy reach of any user with their hands in the glove ports.

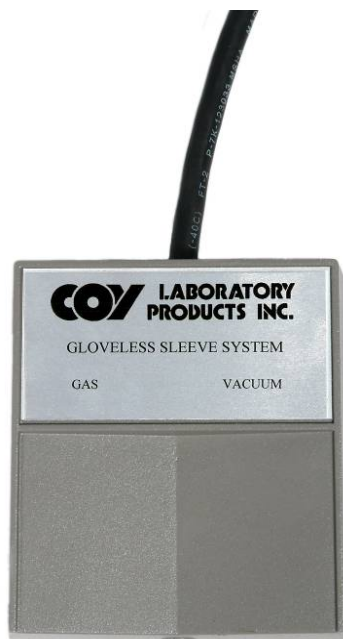

1. Place your arms into the sleeves. Pull the latex cuff up onto your arms until there is a snug fit. Depending on the size of your arms, this may be the upper part of your lower arm, or the lower part of your upper arm.

A tighter, more secure fit is achieved when the cuff is in contact with the users bare skin. If placed over clothing it can result in a slow leak into the system resulting in higher gas consumption.

NOTE: Prior to entry into the glove box this does not have to be a perfect seal as you can make adjustments for comfort and seal more easily once you've entered the glove box interior and your off hand can be make the necessary adjustments.

2. **Two Person Only Units:** Ensure the valve on the side of the Atmosphere Control Cabinet (pictured below) is set to the correct port to be used.



2. Use the Vacuum Side of the Foot Switch (Right Side) to evacuate the sleeves until the sleeve is tight around the users forearms. How “tight” is personnel preference but keep in mind there will be a point of diminishing returns for the time spent.
3. Use the Gas Side of the Foot Switch (Left side) to re-inflate the sleeves.
4. Repeat the above process 1 more time.
5. Now grasp the Arm Port Plug handles and with a slight downward pressure tilt the Plugs into the glove box from the top down. Trying to push the entire Arm Port Plug into the glove box can be extremely difficult as you are pushing against the entire diameter of the Plugs seal.
6. When exiting the glove box reverse the procedure for the Arm Port Plugs, Seeding the bottom portion of the Plug into the Arm Port first and tilting the plug in from bottom to the top with a slight downward pressure.

NOTE: Different size cuffs are available from COY each unit is equipped with 6 pair of cuffs 2 pair of each available size. When reordering note the number marked on each cuff (#7, 8, 9) for proper sizing.

Warning: The Cuff material is a latex rubber for users with latex allergies take a glove of the appropriate material and cut off the glove portion just below the thumb and attach to the neoprene sleeve.

2.7 STAK-PAKS AND CATALYST

The Stak-Paks are wire mesh (#14 size) that allow you to contain the Catalyst, Desiccant, Activated Carbon or other such pellet based chemicals for use inside the glove box. The Stak-Paks are designed to fit the grill above the circulation fan on the airlock side of the glove box. For multiple mounting each Stak-Pak comes with a hole for placing 6-32 Screw through to secure the Stack-Paks Together to ease their use and handling inside the glove box.

Each Stak-Pak can be filled with 180 gm's of material, overloading the Stak-Pak can cause circulation irregularities in the glove box causing unwanted Temperature, Humidity or O₂ Gradients in the glove box.

No more than 1 Catalyst Stak-Paks and 1 other (desiccant or activated carbon) should be mounted more may reduce air circulation.

Figure #7 Catalys Stak-Pak



Catalyst

The Catalyst Is an aluminum pellet coated with palladium. The Palladium provides the reaction between O₂ and H₂ gases inside the chamber. The Catalyst Stak-Paks needs to be regenerated in an oven, at a minimum of once a week at 125-200° C for two hours. Included in the Chamber package are 2 Catalyst Stak-Pak's. Replace the Catalyst you rejuvenate with the extra. Then your Chamber will always have fresh Catalyst. If you have an extremely busy Chamber, you may need to rejuvenate the catalyst more frequently, even on a daily basis.

No more than 1 Catalyst Stak-Pak in operation is required, if you are not removing excess oxygen associated with cycling the airlock as quickly as you once did this is a sign the catalyst is wearing out and new catalyst should be purchased.

OPTIONAL EQUIPMENT

1. ANAEROBIC MONITOR - MODEL 12 (CAM-12)

Coy Labs Oxygen/Hydrogen Analyzer is designed to monitor the oxygen/hydrogen content inside an Anaerobic Chamber. It has two independent digital readouts that display oxygen in parts per million (ppm) and hydrogen in percent(%). To operate the Analyzer simply plug it into a suitable outlet (plug strip) and allow 1 hour for it to stabilize. It will then correctly display the oxygen and hydrogen content inside the Chamber.

For further information on the anaerobic monitor please see the manual.

CAUTION. *Gas mixes containing more than 4% hydrogen may be flammable.*

2. INCANDESCENT FLAMING DEVICE (IFD)

To operate the IFD, plug the unit into the plug strip inside the chamber. Then run the foot switch through a feed through adapter (one will need to be provided at time of order) Every time the foot switch is depressed the IFD turns on, and in a few seconds the "Nichrome" wire loop will turn bright red. To flame a bacteria loop, simply insert the loop into the hot wire coil and withdraw it slowly. When the foot switch is released, the IFD will turn off. The IFD is designed to operate on an intermittent basis only, IT SHOULD NEVER BE LEFT UNATTENDED WHILE IN OPERATION. Periodically, you will have to replace the "Nichrome" wire loop. To do this, unscrew two terminals holding the old "Nichrome" wire loop. Then, insert the new "Nichrome" wire loop and tighten the terminals. You may have to spread the leads on the new loop to achieve a satisfactory fit.

3. ATMOSPHERE FILTER

The Atmosphere Filter consists of a fan, and filter housing, base and power switch. The atmosphere is circulated through the 1/4" X 10" glass fiber filter pad by the fan. This removes 99.9% of airborne contamination with a size of 0.3 micron or larger. The high capacity of the fan and filter media allows you to choose your own filtering cycle, ranging from daily operation to 2-3 times per month depending upon the contamination present.

3.0 Purging the Chamber & Getting Started

- 3.1 This section will explain how to purge the Chamber and establish an anaerobic environment.

NOTE! DO NOT INTRODUCE CATALYST INTO THE CHAMBER UNTIL THE PURGE OPERATION IS COMPLETE.

1. Make sure all switches are in the off position before plugging in the Atmosphere Control Cabinet. Once the Cabinet is plugged and turned ON (switch on side of the Atmosphere Control Cabinet) the circulation fan will begin to function and the touch screen will begin to operate. This is the only item that should be ON during the initial Chamber Purge.

If you have purchased the COY Anaerobic Monitor option you may turn this ON now to begin monitoring of chamber gases, but please note it will not begin to work until gas mix is introduced to the glove box.

4 & 5 ft. Polymer Glove Box Note: A 2nd Circulation Fan is installed on the far end of the glove box. At this time the fan cord should be plugged in, this automatically turns on the circulation fan. This fan should run constantly for uniform mixture of temperature, humidity, and oxygen. The 5 ft. glove box Circulation Fan is equipped with additional temperature controls the temperature set-point should be adjusted below ambient conditions to prevent the heaters from turning on during this initial set-up procedure. This can be confirmed by the green light on the display.

2. Make sure the pressure relief valves are not blocked then access the chamber purge switch on the touch screen controls to initiate the N₂ (background gas) Purge

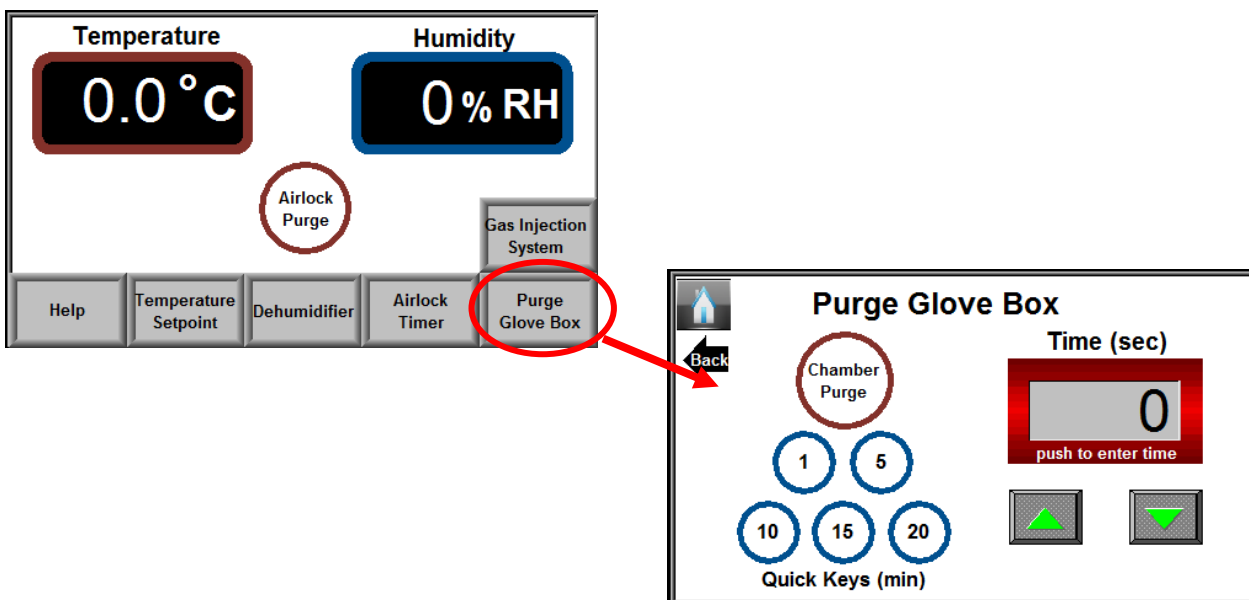

3. Choose a time frame according to the chart below.

Glove Box Size	Purge Time at 15 psi (pounds per square inch)
3 ft. Polymer Glove Box (10.5 cu. ft./297 liters)	300 seconds (5 minutes)
4 ft. Polymer Glove Box (14.5 cu. ft./410 liters)	360 seconds (6 minutes)
5 ft. Polymer Glove Box (18 cu. ft./509 liters)	480 seconds (8 minutes)

Time can be adjust through the quick keys or by touching the Time display to bring up the time menu or through the green arrow keys that adjust the time in 1 minute intervals from the existing reading.

NOTE: Quick Keys display in minutes however once pressed the actual time in the time display will be featured in minutes.

Touch here to bring up the time adjustment menu.

Green Arrow Keys that adjust in 1 minute intervals from the existing reading

4. When the desired time is set press the chamber purge button to start the initial purge. This purge process is done to prep the unit for the introduction of a non-flammable H₂ gas mix. Once the purge process has started you will see a display like this

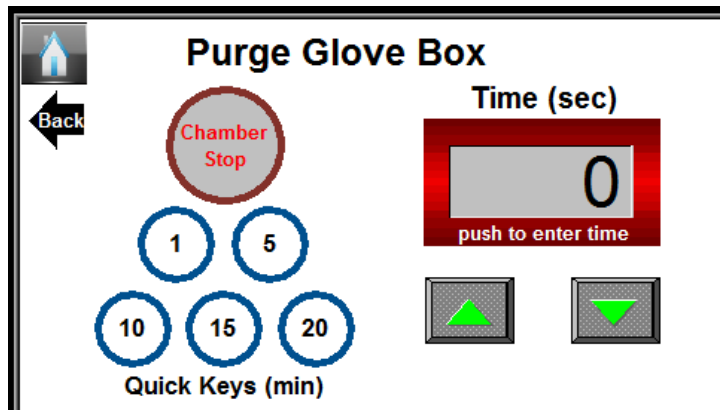

After a delay with no touch screen activity the monitoring of the chamber purge will default to the home screen with the chamber purge displayed as below.

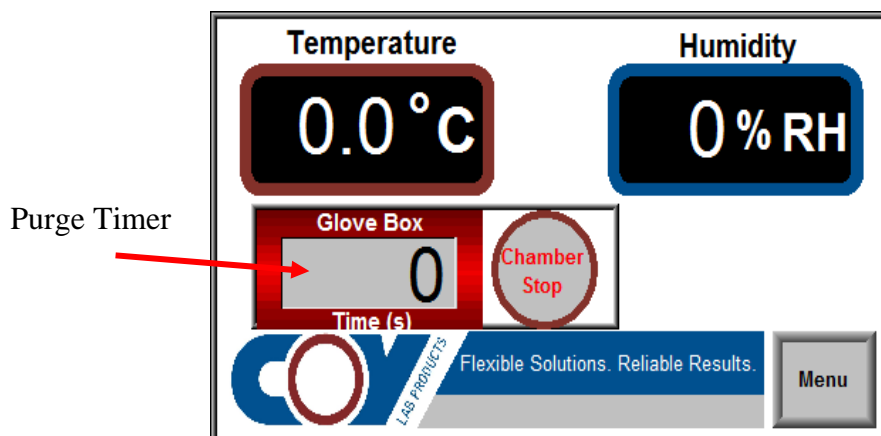

5. After the N₂ (background gas is complete) you can begin to inject the H₂ Gas Mix. This is done through the Gas Injection System. To access use the below screen shots.

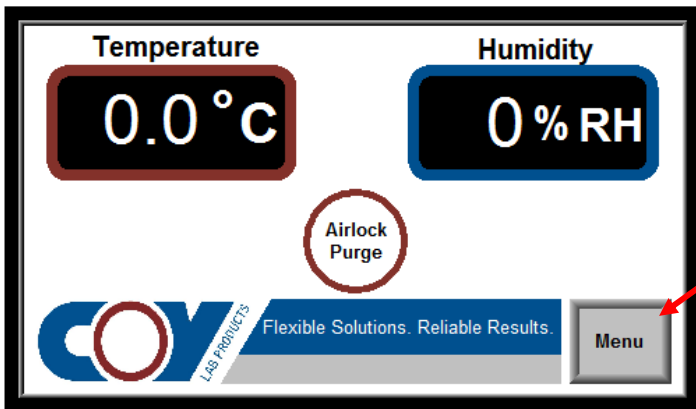

Press Menu

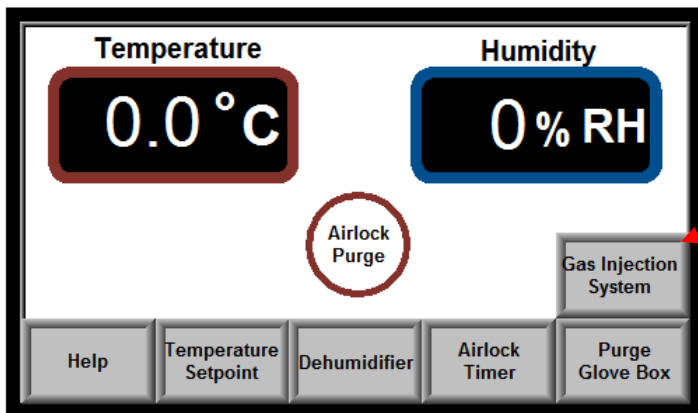

Press Gas Injection System

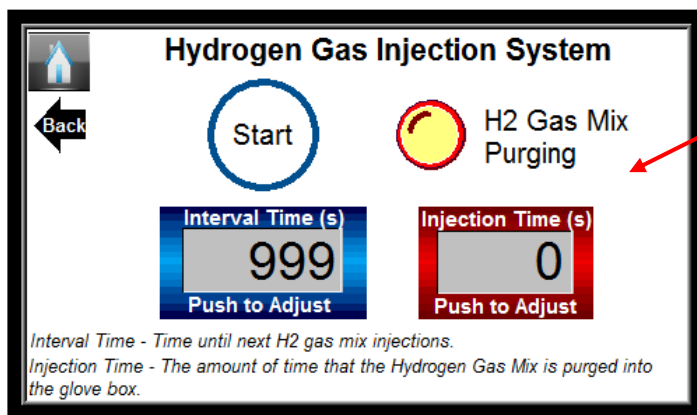

Screen for injection of H2 Gas for initial set-up

AFTER initial N2 purge you now need to inject the H2 gas mix in to your chamber by using the gas injection system.

7. Set the interval time to 1 second.
8. Set the H2 gas mix purge timer to the set time determined by the size of your glove box/chamber (see chart below).

If you have purchased the COY Gas Analyzer, you may simply purge until you achieve the desired hydrogen mix level.

Note: Depending on the glove box size, you will only have a portion of the percent gas mix from the tank, ie; a 5% H₂ mix tank will only produce a 3.5%-4.0% H₂ atmosphere mix inside the glove box maximum.

If you do not have a COY Model 10 Gas Analyzer, use the following chart for approximate purge times necessary to introduce the appropriate hydrogen levels.

Glove Box Size	Purge Time at 15 psi <i>(pounds per square inch)</i>
3 ft. Polymer Glove Box (10.5 cu. ft./297 liters)	120 seconds (2 minutes)
4 ft. Polymer Glove Box (14.5 cu. ft./410 liters)	150 seconds (2.5 minutes)
5 ft. Polymer Glove Box (18 cu. ft./509 liters)	180 seconds (3 minutes)

The Chamber only requires 1% H₂ to function properly however the hydrogen gas is consumed every day through diffusion, airlock activity, and gloveless sleeve use so you can anticipate .2-.4% consumed everyday.

9. Now you may put the catalyst into the fan box or in the atmosphere control cabinet. Wait 15 minutes and you may need to purge more H₂ gas mix to maintain 2% H₂ in the chamber.

NOTE: Once you are complete with the initial gas mix purge you will want to reset the Gas injection interval timer back to 3600 seconds and purge time for 5 seconds (or whatever you decide is best for your unit).

4.0 THEORY OF DESIGN

4.1 PALLADIUM CATALYST/GAS REACTION

The following is an explanation of how the catalyst and gases react to remove oxygen so an anaerobic condition may be retained.

The catalyst is constructed of alumina and coated with a thin layer of palladium chloride. The main purpose of the catalyst is to provide a meeting ground for oxygen and hydrogen. Water is formed when oxygen and hydrogen meet in the presence of palladium chloride. The alumina in the catalyst absorbs the water which is driven off during catalyst rejuvenation.

During normal operation, oxygen continuously enters the Chamber by diffusion and other means. Without the presence of hydrogen, the catalyst will not remove oxygen. Hydrogen, unfortunately, cannot enter the chamber by itself; you must introduce it into the chamber.

Part of the COY Gloveless Anaerobic Chamber is to automatically purge the chamber with your gas mix for 5 seconds every 3600 seconds (pre-set at the factory.) This enables you to constantly maintain hydrogen levels necessary to maintain anaerobic conditions.

Using the airlock daily allows hydrogen from the gas mix to enter the chamber when you open the inside door.

Depending on how often you use the Chamber, both methods help to ensure the chamber has hydrogen. However, hydrogen concentration in your chamber will be diluted depending upon the volume of your Chamber. (See Section 2.2.2 following).

Heat is generated by the catalyst when an abundance of oxygen and hydrogen combine. This is apparent when the chamber is initially purged. If the correct guidelines are followed when you purge the chamber, the catalyst will only feel warm to the touch.

4.2 OXYGEN ENTERING THROUGH AIRLOCK

4.2.1. Regardless of how many times the airlock is cycled, there will always be a small amount of oxygen entering the chamber. Removing oxygen is the catalyst's job. This amount differs, depending on the volumetric size of your chamber.

When the airlock's inside door is opened, the gases from the airlock will start to mix with gases in the chamber. Coy has found that gases from the airlock flow out of the airlock and across the chamber floor. If oxygen is present in the gases, it will flow across the chamber floor until it reaches the catalyst, at which time it will be removed (providing you have fresh catalyst and hydrogen present). Because the oxygen concentration is higher in the airlock than in the Chamber, an oxygen gradient is created. Oxygen levels are greatest at the airlock door and become progressively less as the distance from the door increases.

4.3 CONTROLLING MOISTURE

4.3.1. ENTERING MOISTURE

Moisture can enter the chamber in several ways:

1. GAS SUPPLY TANKS (NITROGEN/GAS MIX)
2. AMBIENT MOISTURE IN THE AIRLOCK
3. MOISTURE PRODUCING MATERIAL IN THE CHAMBER
4. MIGRATION THROUGH THE CHAMBER WALLS
5. HUMIDITY CAUSED BY BEING LOCATED IMMEDIATELY BELOW AN AIR CONDITIONING UNIT

The built in Dehumidifier (peltier cell) will remove the majority of this moisture and maintain non-condensing humidity levels.

NOTE: For proper operation the fans on the Atmosphere Control Cabinet must not be blocked

5.0 CARE AND MAINTENANCE

5.1 CARE OF POLYCARBONATE

5.1.1. PRECAUTIONS

There are several precautions you can take to prolong the life of your chamber. Precautions you should carefully follow are:

1. DO NOT USE ABRASIVE CLEANERS AT ANY TIME.
2. DO NOT USE ANY SOLVENT LIKE LIQUIDS TO CLEAN THE PLASTIC. ISOPROPYL ALCOHOL IS ACCEPTABLE.
3. KEEP EQUIPMENT AND SHELVING UNITS WITHIN EASY REACH SO YOU DO NOT STRETCH THE CHAMBER SLEEVES.
4. RINGS AND JEWELRY SHOULD BE REMOVED PRIOR TO USING SO AS NOT SCRATCH THE POLYCARBONATE OR TEAR THE ARMS OR GLOVES.
5. PROTECT THE CHAMBER FROM ORGANIC SOLVENT FUMES AND NEARBY PAINTING AND PLASTERING. IF SPLASHED, WIPE IMMEDIATELY WHILE WET WITH A SOFT CLOTH.

5.1.2. CLEANING THE POLYCARBONATE

Dust and clean with a soft cloth or chamois having first sprayed on a plastic cleaner. (COY part no. 1600-480)

The use of a mild soap or detergent and plenty of water is good. Dry with a soft cloth or chamois.

Minor scratches can be removed by hand polishing. Polishes are best applied with a soft cloth dampened with water first. Several applications may be necessary, but most minor scratches can be reduced and the clarity improved in a short time.

NOTE: If you have purchase\ed the UV Light option with the UV Resistant Acrylic upgrade you can not use any cleaning material other than soapy water. Alcohol and Bleach solutions will degrade the plastic rapidly with the use of the powerful UV Light.

5.2 CARE OF GLOVES

5.2.1. PRECAUTIONS

The arm length gloves are made of neoprene rubber and are susceptible to punctures and tears. Wear cotton gloves when working with sharp objects. Remove jewelry. If a hole is punctured in the glove, it must be replaced.

5.2.2 Gloveless Sleeve & Cuff and Sleeve Length Glove Replacement procedure

Replacement Gloves, Gloveless Sleeves and Replacement Cuffs may be purchased from COY Laboratory Products. Below is an illustration of how to install the replacement items.

Figure #8 Gloveless Sleeve Replacement

1. Place sleeve on chamber.

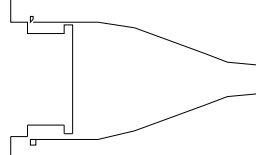

2. Place rubber band over sleeve.

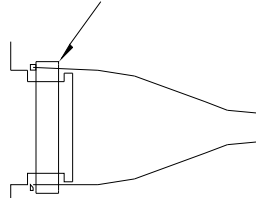

3. Place clamp over rubber band & tighten lightly.

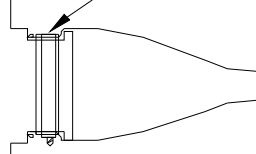

4. Place plastic cuff support over sleeve.

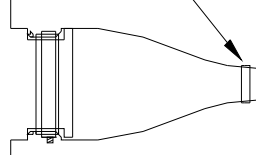

5. Roll sleeve over plastic cuff support.

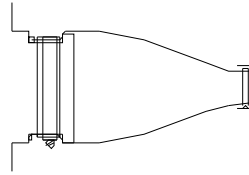

6. Stretch latex cuff over sleeve & cuff support.

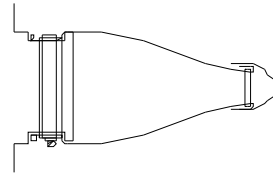

7. Place "O" ring on top of cuff & sleeve in groove of plastic support.

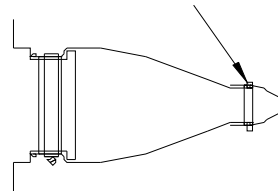

6.0 ANSWERS TO QUESTIONS FREQUENTLY ASKED ABOUT THE CHAMBER

This section answers the most frequently asked questions. Additional questions may be directed to the factory.

Q. 1. HOW MUCH GAS CAN I ANTICIPATE USING WHEN I OPERATE THE CHAMBER ON A ROUTINE BASIS?

A. To purge the airlock for each use will require approximately 3 cu. ft. of gas mix. The initial set up of the Chamber will require approximately 30 cu. ft. Thereafter, use approximately 10 cu. ft. per week to maintain the proper environment. However drastic variations do exist based on care taken with the gloveless sleeves, how often the chamber is used interior volume occupied by equipment, airlock volume used each time samples are transferred.

Q. 2. HOW OFTEN, AT WHAT TEMPERATURE AND FOR HOW LONG DO I REJUVENATE MY CATALYST?

A. Rejuvenating the Catalyst is very important in keeping the Chamber in an anaerobic condition. Rejuvenating the Catalyst a minimum of once a week at 125-200° C for two hours is recommended. Included in the Chamber package are 2 sets of Catalyst Stak-Pak. Replace the Catalyst you rejuvenate with the extra set. Then your Chamber will always have fresh Catalyst. If you have an extremely busy Chamber, you may need to rejuvenate the catalyst more frequently, even on a daily basis.

Q. 3. WHY DOES MY CHAMBER LOSE ITS ANAEROBIC CONDITION OVER A PERIOD OF TIME?

A. There are a couple of variables that must be considered to answer this question. First, does your Chamber have a leak? Second, is the catalyst fresh, have they been rejuvenated? Once these variables have been considered and eliminated from the probable cause, concentrate on the hydrogen content in the Chamber. Deficient hydrogen content is usually the cause for losing anaerobic conditions in the Chamber. Oxygen is constantly entering the Chamber by Airlock use and diffusion through the gloves. Without the hydrogen the catalyst cannot react to remove the oxygen.

You must keep in mind the dilution factor when the gas mix enters the Chamber. If you are using a 5% hydrogen gas mix your Chamber will not contain 5% hydrogen. It will be diluted to approximately 3.5% hydrogen. Coy Labs Oxygen/Hydrogen Analyzer can be used to display the amount of hydrogen in percent that is present in your Chamber. Also, the Analyzer has an alarm that indicates when the hydrogen content goes below 1%. If you have exhausted every probable cause and your Chamber still loses its anaerobic condition, test your gas mix for hydrogen content. We have seen and heard of gas companies that do not comply with customer specifications.

Q. 4. HOW DO I KNOW MY CATALYST IS WORKING AND HOW OFTEN SHOULD I REPLACE IT?

A. A good test to determine if your catalyst is working is to place a tray containing catalyst inside the Airlock. Place a thermometer in direct contact with the catalyst. Then purge the Airlock (manual or automatic) with gas mix containing hydrogen for 10-15 seconds. If the catalyst is working correctly, the temperature will increase due to the reaction of catalyst, oxygen, and hydrogen. Temperature will increase about 10 degrees Celsius over 10 to 15 minutes.

Coy recommends catalyst replacement on a yearly basis or if the catalyst does not respond to the above test.

Q. 5. WHERE DO MOST LEAKS OCCUR IN THE ANAEROBIC CHAMBER?

A. Leaks can occur anywhere in the Chamber but most will be present around work areas. Before you begin leak detection, you must first make sure the Chamber contains your normal amount of pre-mixed gas. A towel saturated with isopropyl alcohol, and allowed to sit in the Chamber for a few minutes, will assist in detecting the very small (slow) leaks. With your gas leak detector, check the following areas first:

1. GLOVES/SLEEVES AND CUFFS
2. ALONG CHAMBER SLEEVES
3. AROUND AIRLOCK SEALS
4. AROUND LARGE DOOR SEALS.

Don't be alarmed if the beeping tone increases slightly around your neoprene rubber gloves. Neoprene rubber has a large pore structure and so will allow hydrogen to diffuse through. Around the gloves, lower the detector sensitivity since the diffusion will give the appearance of a leak.

Q. 6. WHAT WILL THE HYDROGEN SULFIDE PRODUCED BY SULFUR BACTERIA DO TO THE CHAMBER AND HOW CAN I CONTROL IT?

A. It is important to control hydrogen sulfide in the Chamber because it attacks certain metals and can "poison" catalyst. Hydrogen sulfide is especially detrimental to the oxygen and hydrogen sensors in the Gas Analyzer, and to printed circuit boards in other equipment. COY printed circuit boards are coated with a protective substance, but hydrogen sulfide will attack any exposed metal and will, with time, creep under the coating, thus attacking the metal on the boards. The time taken to affect the metal will depend on the concentration of hydrogen sulfide and the humidity level.

To control hydrogen sulfide within the chamber, use one of the following methods:

1. Coy HSRC system

Q. 7. WHAT KIND OF DISINFECTANT CAN I USE IN MY CHAMBER?

- A.
1. With proper care, Isopropyl Alcohol (I.P.A.) or a 1%-2% Clorox solution may also be used.
 2. Per acetic acid may be used to sterilize the chamber.